



# **VHF-Ground Station**

**TG660**

## **Installation and Operation**

Manual DV17900.03

Issue 03 Mai 2018

Article-No. 0639.583-071

## Approved Production and Maintenance Organization

Certificates see: <http://www.becker-avionics.com/company-about/> →Certificates

Contact data for:

**Europe, Asia,  
Oceania and  
Africa**      **Becker Avionics GmbH**  
Baden-Airpark B108  
77836 Rheinmünster (Germany)  
Tel.: + 49 (0) 7229 / 305-0  
Fax: + 49 (0) 7229 / 305-217  
Internet: [www.becker-avionics.com](http://www.becker-avionics.com)  
Email: [info@becker-avionics.com](mailto:info@becker-avionics.com)

**Customer Service:**  
Email: [support@becker-avionics.com](mailto:support@becker-avionics.com)

Contact data for:

**America,  
Australia, Japan**      **Becker Avionics Inc**  
Email: [info@beckerusa.com](mailto:info@beckerusa.com)



### WARNING - USER RESPONSIBILITY

**FAILURE OR IMPROPER SELECTION OR IMPROPER USE OF THE PRODUCTS DESCRIBED HEREIN OR RELATED ITEMS CAN CAUSE DEATH, PERSONAL INJURY AND PROPERTY DAMAGE.**

This document and other information from Becker Avionics GmbH provide product or system options for further investigation by users having technical knowledge.

The user is responsible for making the final selection of the system and components. The user has to assure that all performance, endurance, maintenance, safety requirements of the application are met and warnings be observed.

For this the user has to include all aspects of the application to be compliant with the applicable industry standards and the requirements of the responsible aviation authority. The product documentations from Becker Avionics GmbH have to be observed.

To the extent that Becker Avionics GmbH provide component or system options based upon data or specifications provided by the user, the user is responsible for determining that such data and specifications are suitable and sufficient for all applications and reasonably foreseeable uses of the components or systems.

Term definition: User in the sense of user, installer, installation company.

## Preface

Dear Customer,

Thank you for purchasing a Becker Avionics product. We are pleased that you have chosen our product and we are confident that it will meet your expectations.

For development and manufacturing of our product, the guidelines for highest quality and reliability have been borne in mind, supplemented by selection of high quality material, responsible production and testing in accordance to the corresponding standards.

Our competent customer support department will respond on any technical question you may have. Please do not hesitate to contact us at any time.

## VHF-Ground Station



TG660

design depends on variant

### List of Effective Pages and Changes

Only technical relevant modifications are described in this table.

<b>Document: DV17900.03 / issue 03 Article Number 0639.583 071</b>			
Cover Page	05/2018		
Introduction	05/2018		
Chapter 1 – 5	05/2018		
Issue	Page No.:	Section / Chapter	Description
03	1-60	all	Changed: Editorial adjustments.
	--	all	Added: Descriptions about 25 W and 50 W variant.
	--	1.7	Added/Updated: Details about technical data.
	--	1.7.7	Updated: New certifications.
	--		
	--		
	--		
	--		
	--		
	--		
	--		
	--		
	--		
	--		
	--		

© by Becker Avionics GmbH / all rights reserved

## Table of Contents

<b>1</b>	<b>General Description .....</b>	<b>11</b>
1.1	Introduction.....	12
1.2	Purpose of Equipment.....	13
1.3	Variants Overview .....	13
1.3.1	Software Status.....	13
1.4	Scope of Functionality.....	14
1.4.1	Microphone Inputs .....	14
1.4.2	Audio Outputs .....	14
1.4.3	Side Tone Output.....	14
1.4.4	HMI.....	14
1.4.5	Loudspeaker .....	14
1.4.6	Rear Panel .....	14
1.4.7	Self-Test.....	14
1.4.8	Options.....	15
1.5	Safety-Conscious Utilization .....	15
1.6	Restriction for Use.....	15
1.7	Technical Data .....	16
1.7.1	General Characteristics .....	16
1.7.2	Receiver Data .....	16
1.7.3	Transmitter Data .....	17
1.7.4	Audio Output Data .....	18
1.7.5	RoIP Interface.....	18
1.7.6	Dimensions & Weight.....	18
1.7.7	Certifications .....	19
1.8	Order Code.....	20
1.8.1	TG660 .....	20
1.8.2	Accessories.....	20
1.8.3	Spare Parts .....	21
<b>2</b>	<b>Installation.....</b>	<b>23</b>
2.1	Limitations .....	23
2.2	Packaging, Transport, Storage .....	24
2.3	Device Assignment .....	24
2.3.1	Scope of Delivery.....	24
2.3.2	Additional Required Equipment .....	24
2.3.3	Type Plate.....	25
2.4	Mounting Requirements .....	26
2.4.1	Grounding .....	26
2.4.2	Radio Frequency Radiation .....	26
2.4.3	Antenna Installation .....	26
2.4.4	Lightning Protection .....	27
2.5	Dimensions.....	27
2.5.1	TG660 .....	27
2.6	Connector Pin Assignments.....	28
2.6.1	Connector MIC (Front).....	29
2.6.2	Connector Remote Control (Rear).....	29
2.6.3	Connector Record/DF (Rear).....	30
2.6.4	Connector LINE / AUX (Rear).....	31
2.6.5	Connector EXT. DC (Rear).....	32
2.6.6	Connector AC/Line Power Supply (Rear).....	32
2.6.7	Reflectometer / RF Power Monitor .....	33
2.7	Wiring.....	33
2.7.1	Microphone Connection .....	33
2.7.2	Record/DF Connection .....	33
2.7.3	LINE / AUX Connection .....	34
2.7.4	Auxiliary Voltage Output .....	35
2.8	Configuration via PC .....	36
2.8.1	Preparing the PC .....	36
2.8.2	Operating via PC.....	37
2.9	Post Installation Check.....	38
2.9.1	Mechanical Installation and Wiring Check.....	38
2.9.2	Power Supply.....	38

- 2.9.3 Receiver / Transmitter Operation ..... 38
- 2.9.4 Antenna Check..... 38
- 3 Operating Instructions ..... 39**
- In this chapter you can read about: ..... 39
- 3.1 Device Description..... 39
  - 3.1.1 Device Assignment ..... 39
  - 3.1.2 Packing, Transport, Storage ..... 39
  - 3.1.3 Scope of Delivery ..... 39
  - 3.1.4 Type Plate ..... 39
  - 3.1.5 Controls and Indications..... 40
- 3.2 Start up ..... 41
  - 3.2.1 Power ON..... 42
  - 3.2.2 Power on Built In Test (PBIT)..... 42
- 3.3 Operating..... 43
  - 3.3.1 Keypad ..... 43
  - 3.3.2 SPKR Key ..... 44
  - 3.3.3 Mode Key ..... 44
  - 3.3.4 SQL Key ..... 45
  - 3.3.5 PTT Key ..... 45
  - 3.3.6 Storage Procedure ..... 46
- 3.4 Operating via PC ..... 47
  - 3.4.1 Interface RoIP ..... 47
  - 3.4.2 Menus..... 48
- 3.5 Selectable Frequencies ..... 49
- 3.6 Contact Data..... 50
- 4 Certificates ..... 51**
- 4.1 Certificate-Info ..... 51
- 4.2 BAF Approval - TG660 ..... 52
- 4.3 EC Declaration of Conformity – TG660-05 ..... 54
- 4.4 EC Declaration of Conformity – TG660-10 ..... 56
- 4.5 CE Declaration of Conformity – TG660-25, TG660-50 ..... 58
- 4.6 Approval - Telecommunication Office Italy – TG660-05, TG660-10 ..... 59
- 5 Index..... 60**

**List of Figures**

- Figure 1: System: TG660 with "Radio over IP" (RoIP) Option..... 15
- Figure 2: Type Plate (Example)..... 25
- Figure 3: N-Surge-Suppressor: Lightning Protection..... 27
- Figure 4: TG660 – Dimensions ..... 27
- Figure 5: TG660 Front Interface ..... 28
- Figure 6: TG660 Rear Interface ..... 28
- Figure 7: TG660 - Connector MIC (Front) ..... 29
- Figure 8: TG660 - Connector Remote Control (Rear) ..... 29
- Figure 9: TG660 - Connector Record/DF (Rear) ..... 30
- Figure 10: TG660 - Connector LINE / AUX (Rear) ..... 31
- Figure 11: TG660 - Connector EXT. DC (Rear) ..... 32
- Figure 12: TG660 - Connector AC/Line Power Supply (Rear)..... 32
- Figure 13: PC configuration: LAN network ..... 36
- Figure 14: PC configuration: IP-address, sub net mask ..... 37
- Figure 15: TG660 – Controls and Indications..... 40
- Figure 16: TG660 – Display after power on..... 42
- Figure 17: TG660 – PBIT, 1.Step..... 42
- Figure 18: TG660 – PBIT, 2.Step..... 42
- Figure 19: TG660 – PBIT, 3.Step..... 42
- Figure 20: TG660 – PBIT, 4.Step..... 43
- Figure 21: TG660 – PBIT, 5.Step..... 43
- Figure 22: TG660 – PBIT, 6.Step..... 43
- Figure 23: Interface: TG660 Radio over IP..... 47
- Figure 24: System page1 - Radio Settings..... 48

## List of Abbreviations

### List of Abbreviations

AC	Advisory Circular Alternating Current
AF	Audio Frequency
AUX	Auxiliary
BAF	Bundesaufsichtsamt für Flugsicherung (Federal Supervisory Authority for Air Navigation Services)
DC	Direct Current
ETSI	European Telecommunication Standards Institute
FAA	Federal Aviation Administration
GND	Ground
HMI	Human Machine Interface
I&O	Installation & Operation
ICAO	International Civil Aviation Organization
LCD	Liquid Crystal Display
M&R	Maintenance & Repair
PBIT	Power-On Built In Test
PC	Personal Computer
PTT	Push to Talk
RX	Receive
SPKR	Speaker (Loudspeaker)
SQL	Squelch
TX	Transmit
VHF	Very High Frequency
VSWR	Voltage Standing Wave Ratio

## Units

### Units

A	Ampere
mA	Milliampere
°C	Degree Celsius
cm	Centimeter
dBm	Power Ratio In Decibel referenced to 1 mW
dB	Decibel
g	Gram
kg	Kilogram
kHz	Kilohertz
MHz	Megahertz
mm	Millimeter
Ohm ( $\Omega$ )	Resistance
s	Second
V	Volt
mV	Millivolt
W	Watt
mW	Milliwatt
"	Inch
°	Angular degree

## General Safety Definitions



**DANGER** Indicates a hazardous situation which, if not avoided, will result in death or serious injury.



**WARNING** Indicates a hazardous situation which, if not avoided, could result in death or serious injury.



**CAUTION** Indicates a hazardous situation which, if not avoided, could result in minor or moderate injury.



**NOTICE** Is used to address practices not related to physical injury.



**SAFETY INSTRUCTIONS** Safety instructions (or equivalent) signs indicate specific safety-related instructions or procedures.



## Disposal

### **CAUTION**

The packaging material is inflammable, if it is disposed of improperly by burning, toxic fumes may develop.

This product contains materials that fall under the special disposal regulation, which corresponds to the EC directive for dangerous disposal material. We recommend disposing of the respective materials in accordance with the respectively valid environmental laws.

Dispose circuit boards via a technical waste dump which is allowed to take on e.g. electrolytic aluminium capacitors. Do under no circumstances dump the circuit boards with normal waste dump.

### **NOTICE**



DO NOT throw the device(s) in municipal waste. This product has been designed to enable proper reuse of parts and recycling. Check local regulations for disposal of electronic products.

DO NOT throw the battery in municipal waste. The symbol of the crossed out wheeled bin indicates that the battery should not be placed in municipal waste.

Information about where old batteries can be disposed free of charge is available at your local authorities.

## Warranty Conditions

### **User conversions and changes are not permitted**

Any change made by the user excludes any liability on our part (excluding the work described in this manual).

- The device must not be opened.
- Do not make any modifications to the device, except for those described in the manual.
- Make connections to the inputs, outputs and interfaces only in the manner described in the manual.
- Fix the devices according to the mounting instructions.  
We cannot provide any guarantee for other mounting methods.

## Conditions of Utilization

### **General introductory notes**

With this device you bought a product which was manufactured and tested before delivery with the utmost care.

Please take your time to read the following notes which you ought to follow closely during installation and operation.

Otherwise all claims under the warranty will become void and a reduced service life or even damages must be expected.

### **CAUTION**

The user is responsible for protective covers and/or additional safety measures in order to prevent damages to persons and electric accidents.

Additional Conditions of Utilization

Please refer to "Safety-Conscious Utilization", page 15.

## Non Warranty Clause

We checked the contents of this publication for compliance with the associated hard and software. We can, however, not exclude discrepancies and do therefore not accept any liability for the exact compliance. The information in this publication is regularly checked, necessary corrections will be part of the subsequent publications.

**Blank Page**

## 1 General Description

### In this chapter you can read about:

1.1	Introduction.....	12
1.2	Purpose of Equipment.....	13
1.3	Variants Overview .....	13
1.3.1	Software Status.....	13
1.4	Scope of Functionality.....	14
1.4.1	Microphone Inputs .....	14
1.4.2	Audio Outputs .....	14
1.4.3	Side Tone Output.....	14
1.4.4	HMI.....	14
1.4.5	Loudspeaker .....	14
1.4.6	Rear Panel .....	14
1.4.7	Self-Test.....	14
1.4.8	Options.....	15
1.4.8.1	Internal Battery .....	15
1.4.8.2	Radio over IP "RoIP" .....	15
1.5	Safety-Conscious Utilization .....	15
1.6	Restriction for Use.....	15
1.7	Technical Data .....	16
1.7.1	General Characteristics .....	16
1.7.2	Receiver Data .....	16
1.7.3	Transmitter Data .....	17
1.7.4	Audio Output Data .....	18
1.7.5	RoIP Interface .....	18
1.7.6	Dimensions & Weight.....	18
1.7.7	Certifications .....	19
1.8	Order Code.....	20
1.8.1	TG660 .....	20
1.8.2	Accessories.....	20
1.8.3	Spare Parts .....	21

This manual describes the operation and installation of the TG660-XX VHF-Ground Stations. The type plate on your device shows the information for identification purposes (see "Type Plate", page 25).

Before starting operation of the device(s) please read this manual carefully, with particular attention to the description referring to your device(s).

## 1.1 Introduction

TG660 is a VHF-transceiver. Depending on the variant, the TG660 is capable of delivering 6 W, 10 W, 25 W or 50 W power (RF-carrier) to an external antenna.

TG660 features:

- Voltage control: TG660 power supply logic is operating with AC-power by default. After AC-power failed, the logic automatically switches over to external DC-power. The moment AC-power becomes available the logic returns back to AC-power source. TG660-25 and TG660-50 will draw current partially also from DC source in case both power sources are connected.
- Battery (option for 6 W and 10 W variants): An optional internal 12 VDC rechargeable battery inside the TG660 provides power to continue operation with reduced RF power 6 W over a certain time if AC and external DC supply voltage fail at the same time.
- Radio over IP (option): This option allows the TG660 to be connected to a Local Area Network and the radio communication is performed over IP. In addition this option provides remote monitoring and control capabilities via a PC and a web browser.
- TG660 has a user-friendly HMI; all main components are on the front panel.
  - 2-line 16-character liquid-crystal display (LCD)  
The selected frequency and operating status of the equipment, displayed on the LCD, inform about the current operating mode.
  - Several control elements (rotating knob and buttons),  
enables the user to change operating modes or operating frequency. Standby switch selected to "Standby" partially shuts down the TG660 internal power supply. Some power supply circuits continue listening to the "Standby Switch" to repower the device at any time.
- The "ON/OFF" switch on the front panel switches the TG660 on and off.
- TG660 VHF transceiver is protected against jammed transmit button or short circuit on the PTT line.
- TG660 VHF transceiver is protected against antenna mismatch.

For further descriptions we are also use the term TG660 instead writing the complete model number.

The manual "Installation and Operation (I&O) contains the following sections:

Section	DV17900.03 I&O
General	X
Installation	X
Operation	X
Theory of Operation	N/A
Maintenance and Repair	N/A
Illustrated Parts List	N/A
Modification and Changes	N/A
Circuit Diagrams	N/A
Certifications	X
Attachments	N/A

### 1.2 Purpose of Equipment

- TG660 is a fixed station for voice communications in the VHF frequency range of 118.000...136.990 MHz with 25 kHz / 8.33 kHz channel spacing.
- TG660 is useable on airports with different scale as a main transceiver or as a standby device, as well as for special tasks within the scope of air traffic control.
- Designed for mounting in 19" rack systems, or in ATC desks.
- Operating with AC supply voltage from 100...230 V or with 24 VDC.

### 1.3 Variants Overview

Within the part number, the meaning of "-XX " is:

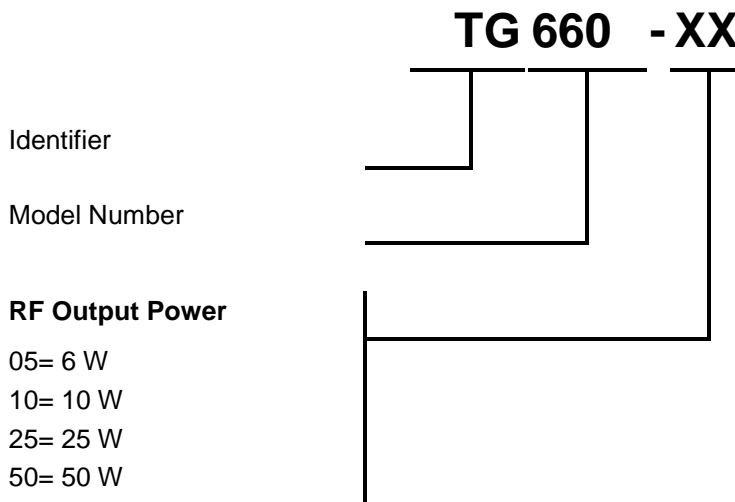

**Available options:**

Battery option and RoIP option, details see "Options" page 15.

#### 1.3.1 Software Status

Descriptions see "Type Plate", page 25.

## 1.4 Scope of Functionality

### 1.4.1 Microphone Inputs

Several microphone inputs are available for:

- Standard microphone unbalanced, DC coupled and providing power supply for the mike.
- Dynamic mike input balanced.
- Symmetrical balanced input.

These microphone inputs connect to a dynamic volume compressor inside of the transceiver, which keeps the modulation voltage constant  $\geq 80\%$  over a wide mike signal input voltage range.

### 1.4.2 Audio Outputs

TG660 has different outputs:

- Headphone output
- Speaker output
- Line out
- Voice recorder

### 1.4.3 Side Tone Output

In transmit mode, the side tone signal is routed to the "Line out" and "Headphone output".

### 1.4.4 HMI

The TG660 HMI provides a LC Display, a keypad, various function switches and the volume control. In addition, operation with a standard Web Browser via IP is provided (see "Radio over IP "RoIP", page 15).

### 1.4.5 Loudspeaker

The loudspeaker, located behind the front panel, is switched off automatically during TX. This avoids acoustic coupling between loudspeaker and the microphone.

### 1.4.6 Rear Panel

TG660 rear panel layout:

- Terminal for ground connection.
- AC power connector with integrated ON/OFF switch and safety fuse.
- Fuse 1 (DC extern input).
- Fuse 2 (internal battery if installed) or Power Amplifier for TG660-25 and TG660-50.
- DC extern socket (STAKEI 2 connector).
- LAN socket (RJ45).
- Remote connector (D-sub).
- Record / DF connector (D-sub).
- LINE / AUX connector (D-sub).
- Antenna connection (N-Type).
- Adjustments for internal reflectometer (TG660-25, TG660-50).

### 1.4.7 Self-Test

After power "ON" a system self-test is performed. Detected errors would be shown up on the display otherwise the device changes into the last used operation mode.

## 1.4.8 Options

Following options are available for the TG660 variants.

### 1.4.8.1 Internal Battery

An optional internal 12 VDC battery (rechargeable) inside the TG660 (only 6 W and 10 W variants) provides power supply to continue operation over a certain time if AC and external DC supply voltage fail at the same time.

Please note the TG660 functionality will be limited during operation in battery mode:

- Reduced RF power 6 W.
- Limited remote operation available.

### 1.4.8.2 Radio over IP "RoIP"

The Radio over IP (RoIP) option provides the possibility to connect the desktop control heads via the local area network (LAN) to the transceiver. Thus common infrastructure can be used and almost unlimited distances can be bridged. As audio data and control data are transformed to TCP/IP over Ethernet no degradation of voice quality is present. Furthermore, connections via the Internet can be used.

Besides the voice communication also control signals are transferred via the LAN and thus provide Remote Control & Monitoring functionality to the user. The configuration of the TG660 may be changed via a web interface.

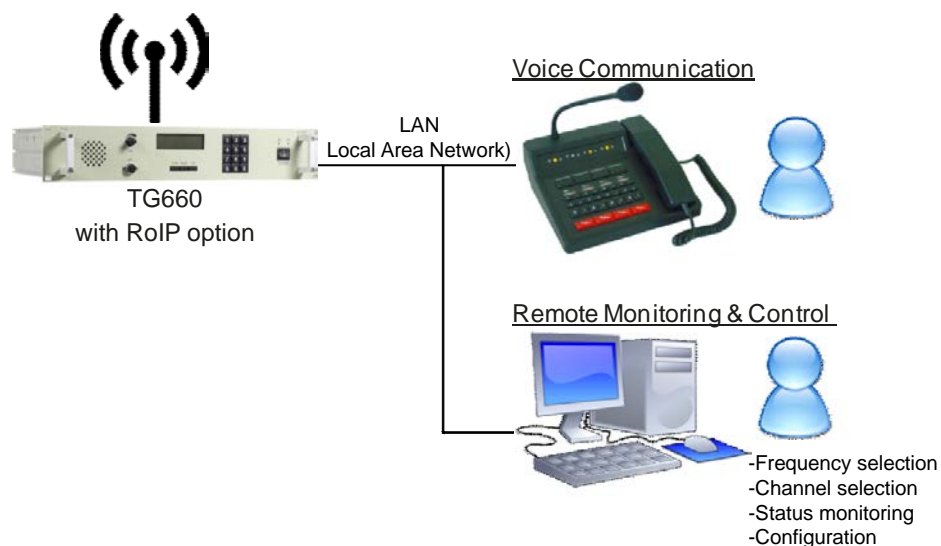

Figure 1: System: TG660 with "Radio over IP" (RoIP) Option

## 1.5 Safety-Conscious Utilization

For safe operation of the product the following notes have to be observed:

### SAFETY INSTRUCTIONS

- The installation may be carried out only by authorized personnel. The country regulations always have to be observed.
- Use the product only within the specified conditions, see "Technical Data", page 16.

## 1.6 Restriction for Use

### SAFETY INSTRUCTIONS

The product is to be used inside the declared limits.

## 1.7 Technical Data

### 1.7.1 General Characteristics

TG660	Specifications
Power supply (AC)	90...264 V, 47...63 Hz
Power supply (DC external)	24...29.8 V nominal (21...24 V emergency voltage)
Frequency range	118.000...136.990 MHz
Channel spacing	8.33 / 25 kHz automatically selected
Number of channels	
25 kHz channel spacing	760 (118.000...136.975)
8.33 kHz channel spacing	2280 (118.000...136.990)
Modulation type	AM
25 kHz	6K80A3EJN
8.33 kHz	5K00A3EJN
Warm up time	5 s
Duty cycle	RX:TX = 4:1
Voice recorder output	-3 dBm, +3 / -12 dB @ 600 Ω, balanced
Temperature range	Operating: -20...+55 °C Storage: -55...+85 °C
Humidity	48 h, 50 °C, 95% relative humidity, without condensation

### 1.7.2 Receiver Data

TG660 Receiver Data	Specifications
Sensitivity (Mod. depth 30%):	-101 dBm for a SINAD of 12 dB nominal -107 dBm for a SINAD of 6 dB (-101 dBm equals 1.993 μV; -107 dBm equals 1 μV)
Adjacent channel rejection	≥ 60 dB
Spurious response rejection	≥ 70 dB
Intermodulation response rejection	≥ 70 dB
Blocking or desensitisation	> 99 dB
Cross modulation rejection	≥ 95 dB
Harmonic Distortion (THD)	m = 30% ≤ 5% m = 90% ≤ 10%



TG660 Receiver Data	Specifications
Effective bandwidth:	
25 kHz channel spacing	± 8.5 kHz
8.33 kHz channel spacing	± 2.8 kHz
AGC characteristic	≤ 6 dB in range -101...-1 dBm
Audio frequency response:	
25 kHz channel spacing	-4 dB / +2 dB 300...3400 Hz relative to 1000 Hz
8.33 kHz channel spacing	-4 dB / +2 dB 350...2500 Hz relative to 1000 Hz
Squelch operation	6 dB (S+N)/N up to 12 dB, adjustable by software setting, override level -85 dBm
Audio noise	≥ 40 dB (S+N)/N
RF-input level range	-101 dBm up to 10 dBm
RF-dynamic range	6 dB AF variation for 100 dB RF variation
AF-AGC for 30% m 90%	max. 1.5 dB AF-level variation

### 1.7.3 Transmitter Data

TG660 Transmitter Data	Specifications
Carrier power	TG660-05: ≥ 6 W TG660-10: ≥ 10 W TG660-25: 25 W, ± 1.5 dB TG660-50: 50 W, ± 1.5 dB
Frequency stability	≤ 1 ppm
Protection of the transmitter	VSWR = 6 without any damage
Modulation depth	≥ 85%
Modulation distortion	≤ 10%
Audio frequency response	
25 kHz channel spacing	-4 dB / +2 dB in band 300...3400 Hz relative to 1000 Hz ≤ -25 dB above 5000 Hz
8.33 kHz channel spacing	-4 dB / +2 dB in band 350...2500 Hz relative to 1000 Hz ≤ -25 dB above 3200 Hz
Adjacent channel power	60 dB (25 kHz) 50 dB (8.33 kHz)
AF-line input level	-20...10 dBm adjustable
AF-line input impedance	600 Ω ± 10%, balanced
Local mike sensitivity (dyn.)	2...10 mV @ 200 Ω, balanced

### 1.7.4 Audio Output Data

TG660	Specifications
Output power headphone	≥ 100 mW @ 600 Ω
Output power loudspeaker	≥ 4 W sin @ 4 Ω
Output level nominal LINE_OUT AF	-53 dBm...10 dBm
Output level headphone, speaker	adjustable with volume potentiometer (-30...0 dBm)
Output level voice recorder	-60 dBm...7 dBm
AF-line output impedance	600 Ω +/- 10%, balanced
Local headphone output power	≥ 1.5 V @ 600 Ω, unbalanced, volume control via front panel
Ext./int. speaker power	≥ 4 W sinus @ 4 Ω, volume control via front panel

### 1.7.5 RoIP Interface

TG660	Specifications
Protocol	TCP/UDP
AF transmission	PCM, 8 bit, 8 kbit/s, A-Law, G.711

### 1.7.6 Dimensions & Weight

TG660	Specifications
Dimensions H x W	
case only:	86.5 x 428 mm (3.40 x 16.85 inch)
complete device 19":	88.1 x 482.6 mm (3.47 x 19 inch)
Mounting depth	280 mm (11.02 inch)
Mounting	in 19"rack systems or in ATC desks
Material	Aluminium housing
Surface treatment	Front plate powder coated RAL 7032
Weight	
TG660-05, TG660-10	4.5 kg (9.92 lbs)
TG660-05, TG660-10 with internal battery	6.5 kg (14.33 lbs)
TG660-25, TG660-50	6.5 kg (14.33 lbs)

**1.7.7 Certifications**

Certifications/Approvals applies only to:

- TG660-05 and TG660-10 used with transceivers GT6201-05-R and GT6201-10-R (details see "Certificates", page 51).

**SAFETY INSTRUCTIONS**

Unauthorized changes or modifications to TG660 (GT6201-XX-R) may void the compliance to the required regulatory agencies and authorization for continued equipment usage.

Part Number	Article Number	Approval
TG660-05	0635.367-926	BAF - German Federal Supervisory Office for Air Navigation Services D-0046/2017
TG660-10	0635.375-926	BAF - German Federal Supervisory Office for Air Navigation Services D-0046/2017
GT6201-05-R	0641.073-923	BAF - German Federal Supervisory Office for Air Navigation Services D-0030/2014
		Ministero Sviluppo Economico – Dipartimento per le Comunicazioni Registro ufficiale, Prot.n. 0041697-02/07/2014
GT6201-10-R	0641.081-923	BAF - German Federal Supervisory Office for Air Navigation Services D-0030/2014
		Ministero Sviluppo Economico – Dipartimento per le Comunicazioni Registro ufficiale, Prot.n. 0041697-02/07/2014

TG660 and GT6201 meet the requirements of ETSI EN 300 676 regulations and is FCC certified (FCC ID: 2AHX9TG660).

## 1.8 Order Code

### 1.8.1 TG660

Qty	Device	
1	TG660-05, 19" Device $\geq$ 6 Watt RF Power Output	Article No. 0635.367-926
1	TG660-10, 19" Device, $\geq$ 10 Watt RF Power Output	Article No. 0635.375-926
1	TG660-25, 19" Device, 25 Watt RF Power Output	Article No. 0654.132-926
1	TG660-50, 19" Device, 50 Watt RF Power Output	Article No. 0649.252-926

Qty	Options	
1	Internal battery option (12 V)	Article-No. 0640.131-958
1	Radio over IP "RoIP" option	Article-No. 0640.141-958

### 1.8.2 Accessories

Qty	Antenna, additional equipment	
1	1A049, Antenna	Article-No. 0812.064-952
1	N-Surge Suppressor (lightning, overvoltage protection)	Article-No. 0600.891-277
1	Accessory Kit (for TG660-05, TG660-10) <ul style="list-style-type: none"> <li>• K-connector 3pol.</li> <li>• Power supply cable and connector</li> <li>• Fuse 5x20 T 2.5 A</li> <li>• Fuse 5x20 T 1.6 A</li> </ul>	Article-No. 0647.667-919

Qty	Cable connector	
1	24 V cable connector	Article-No. 0724.890-277
1	N-Type antenna connector for RG213/214 coaxial cable	Article-No. 0716.502-277
1	D-sub 9pin (male), soldering version	Article-No. 0344.699-277
1	D-sub 15pin (male), soldering version	Article-No. 0726.303-277
1	D-sub 25pin (male), soldering version	Article-No. 0584.940-954
1	D-sub 9pin (male), crimp version	Article-No. 0820.970-277
1	D-sub 15pin (male), crimp version	Article-No. 0812.803-227
1	D-sub 25pin (male), crimp version	Article-No. 0584.983-954

Qty	Headsets, microphone	
1	1PM012, Dynamic microphone with cable and 5-pole DIN connector	Article-No. 0344.214-951
1	1PH028, Headset, <ul style="list-style-type: none"> <li>• Dynamic microphone, 200 <math>\Omega</math></li> <li>• Headphone 300 <math>\Omega</math>, 5-pin DIN connector</li> </ul>	Article-No. 0860.557-951
1	1PH032, Headset, <ul style="list-style-type: none"> <li>• Dynamic microphone, 200 <math>\Omega</math></li> <li>• Headphone 600 <math>\Omega</math>, 5-pin DIN connector</li> </ul>	Article-No. 0653.853-951

Qty	Available Documentation	
1	TG660 Installation and Operation Manual, English	Article-No. 0639.583-071

### 1.8.3 Spare Parts

Qty	Battery	
1	Battery, 12 V, 3.5 Ah, rechargeable	Article-No. 0647.454-391

Qty	Fuse	
1	Fuse 5x20 T 1.6 A (external power supply AC)	Article-No. 0762.751-392
1	Fuse 5x20 T 2.5 A (external power supply DC, internal battery)	Article-No. 0647.659-392
1	Fuse 5x20 T 15 A (external power supply DC, power amplifier)	Article-No. 0661.147-392

**Blank Page**

## 2 Installation

This manual must be available close to the device during the performance of all tasks.

The installation of TG660 depends on the location and its equipment. Therefore, this section only provides general information.

Careful planning should be applied to achieve the desired performance and reliability from the product. Any deviations from the installation instructions prescribed in this document are under own responsibility.

### In this chapter you can read about:

2.1	Limitations .....	23
2.2	Packaging, Transport, Storage .....	24
2.3	Device Assignment .....	24
2.3.1	Scope of Delivery.....	24
2.3.2	Additional Required Equipment .....	24
2.3.3	Type Plate .....	25
2.4	Mounting Requirements.....	26
2.4.1	Grounding .....	26
2.4.2	Radio Frequency Radiation .....	26
2.4.3	Antenna Installation .....	26
2.4.4	Lightning Protection .....	27
2.5	Dimensions.....	27
2.5.1	TG660 .....	27
2.6	Connector Pin Assignments.....	28
2.6.1	Connector MIC (Front) .....	29
2.6.2	Connector Remote Control (Rear).....	29
2.6.3	Connector Record/DF (Rear).....	30
2.6.4	Connector LINE / AUX (Rear).....	31
2.6.5	Connector EXT. DC (Rear).....	32
2.6.6	Connector AC/Line Power Supply (Rear).....	32
2.6.7	Reflectometer / RF Power Monitor .....	33
2.7	Wiring.....	33
2.7.1	Microphone Connection .....	33
2.7.1.1	Mike Connector (MIC) .....	33
2.7.1.2	External Microphone (LINE AUX) .....	33
2.7.2	Record/DF Connection .....	33
2.7.2.1	AF Output to Voice Recorder .....	33
2.7.2.2	Voice Recorder Control .....	34
2.7.2.3	Direction Finder Blank-Out .....	34
2.7.3	LINE / AUX Connection .....	34
2.7.3.1	PTT .....	34
2.7.3.2	External Speaker .....	34
2.7.3.3	Headphone .....	34
2.7.3.4	LINE IN / LINE OUT .....	35
2.7.3.5	SQL - LINE .....	35
2.7.3.6	Input PTT MIKE_EXT (HI/LO) .....	35
2.7.4	Auxiliary Voltage Output .....	35
2.8	Configuration via PC .....	36
2.8.1	Preparing the PC .....	36
2.8.2	Operating via PC.....	37
2.9	Post Installation Check.....	38
2.9.1	Mechanical Installation and Wiring Check .....	38
2.9.2	Power Supply .....	38
2.9.3	Receiver / Transmitter Operation.....	38
2.9.4	Antenna Check .....	38

### 2.1 Limitations

- TG660 is designed for mounting in 19" rack systems or in ATC desks.



Unauthorized changes or modifications may void the compliance to the required regulatory agencies and authorization for continued equipment usage.

## 2.2 Packaging, Transport, Storage

Visually inspect the package contents for signs of transport damage.

**⚠ CAUTION** The packaging material is inflammable, if it is disposed of improperly by burning, toxic fumes may develop.

The packaging material can be kept and reused in the case of a return shipment. Improper or faulty packaging may lead to transport damages.

Make sure to transport the device always in a safe manner and with the aid of suitable lifting equipment if necessary. Do never use the electric connections for lifting. Before the transport, a clean, level surface should be prepared to place the device on. The electric connections may not be damaged when placing the device.

### First Device Checkup

- Check the device for signs of transport damages.
- Please verify if the indications on the type plate correspond to your purchase order.
- Check if the equipment is complete ("Scope of Delivery", page 24).

### Storage

If you do not wish to mount and install the device immediately, make sure to store it in a dry and clean environment. Make sure that the device is not stored near strong heat sources and that no metal chippings can get into the device.

## 2.3 Device Assignment

This manual is valid for the following devices and its options

- TG660-05
- TG660-10
- TG660-25
- TG660-50

### 2.3.1 Scope of Delivery

- Manual
  - Installation & Operation
- Device in accordance with your order
- Device accessories
  - Mains cord (AC connection)
  - Cable connector 24 V
  - Spare fuses

### 2.3.2 Additional Required Equipment

- Antenna
- N-Surge Suppressor (recommended)
- Mounting material
- Connector kits
- Cable harness
- Microphone
- Headphone or speaker

Details see "Accessories", page 20.



### 2.3.3 Type Plate

The device type is defined by the type plate (on the housing):

Example:

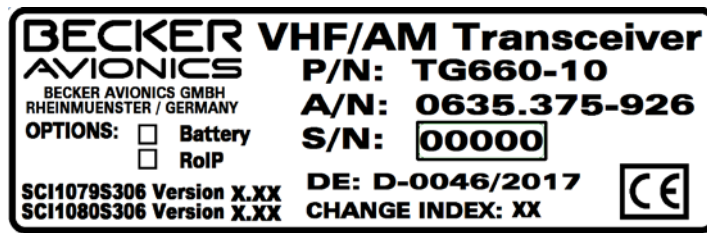

Figure 2: Type Plate (Example)

#### Explanation:

<b>P/N:</b>	<p><b>Example Type designation: TG660-10</b>  <b>TG660:</b> 19" VHF Ground Transceiver Station  <b>Variants:</b>                  -05: 6 Watt Transceiver                  -10: 10 Watt Transceiver                  -25: 25 Watt Transceiver                  -50: 50 Watt Transceiver  <b>Options:</b>  <input type="checkbox"/> <b>Battery:</b> Internal battery option  <input type="checkbox"/> <b>RoIP:</b> Radio over IP option</p>
<b>S/N:</b>	Unique number of the particular device
<b>A/N:</b>	Article number
<b>Change Index:</b>	Number of changes/modifications
	<p><b>Software</b>                  Corresponding to the displayed version</p>
	<p><b>Compliance and Certifications</b>                  Corresponding to the displayed text and logos</p>

## 2.4 Mounting Requirements

For safe operation of the product the following notes have to be observed:

### SAFETY INSTRUCTIONS

- The installation may be carried out only by authorized personnel. The country regulations always have to be observed.
- Use the product only within the specified conditions, see "Technical Data", page 16.

### SAFETY INSTRUCTIONS

- The device must not be opened.
- TG660 generates only limited heating, thus requiring no specific cooling system. However, consider sufficient space for convection at installations in a rack or a controller desk.

### ⚠ WARNING

- When performing maintenance/installation work, always disconnect the system from the power supply grid (mains voltage).
- Stay always in a sufficient distance to the antenna avoiding been exposed to higher RF radiation during TX operation.

### 2.4.1 Grounding

TG660 must be connected to the grounding point of the building.

The grounding terminal is located on the rear side, of the TG660 (marked grounding symbol).

- Connect this terminal directly to the next potential equalisation rail or grounding point of the building.
- Wire cross section: recommended 6 mm<sup>2</sup>, coloured green/yellow.

### SAFETY INSTRUCTIONS

Make sure that the grounding contact area is adequate and that the connection has low resistance and low inductance. Never use a grounding point on paint-coated surfaces!

### 2.4.2 Radio Frequency Radiation

Use only antenna systems which are qualified for operation in ATC mobile communications service. And for which the radio frequency radiation hazard awareness operations and maintenance personal is provided.

### ⚠ WARNING

The station may become a cause of radio frequency radiation hazard if installation incorrectly, not grounded, or if used with unapproved antenna systems.

### 2.4.3 Antenna Installation

### SAFETY INSTRUCTIONS

- For safety reasons the antenna system should be installed only by qualified personnel.
- Correct installation and grounding of the antenna system is an essential precondition for trouble free operation of the VHF ground station.

### 2.4.4 Lightning Protection

Install a lightning protection element in the antenna coaxial cabling to protect the station from lightning strike or static discharge at the antenna.

- Connect the grounding terminal of the lightning protection element to the potential equalization rail of the building or any other low impedance ground.
- Use an adequately sized cable.



Figure 3: N-Surge-Suppressor: Lightning Protection

## 2.5 Dimensions

### 2.5.1 TG660



design depends on variant

Figure 4: TG660 – Dimensions

Dimensions TG660		
H1	(height)	86.5 mm (3.40 inch)
W1	(width)	428 mm (16.85 inch)
H2	(height)	88.1 mm (3.47 inch)
W2	(width)	482.6 mm (19 inch)
D	(depth)	280 mm (11.02 inch)

## 2.6 Connector Pin Assignments



design depends on variant

Figure 5: TG660 Front Interface

Variant		Function
all	A	Loudspeaker
all	B	Volume
all	C	Microphone connector
all	D	Display
all	E	Keys+LEDs: SPKR, MODE, SQL, PTT
all	F	Key block: numbers and functions
all	G	AC/DC LEDs
all	H	Standby switch
TG660-25, -50	I	VSWR LED (antenna mismatching = lights up)



design depends on variant

Figure 6: TG660 Rear Interface

Variant		Function	Type
all	1	Ground terminal	M4 screw with nut
all	2	AC connector, ON/OFF switch + LED	Main plug power supply (integrated ON/OFF switch and safety fuse)
all	3	Fuse external DC power supply	see "Spare Parts", page 21
TG660-05, -10	4	Fuse internal battery	see "Spare Parts", page 21
TG660-25, -50	4	Fuse power amplifier (PA)	
all	5	DC extern connector	STAKEI 2
all	6	LAN connector	RJ45
all	7	Remote connector	D-sub 9pin (female)
all	8	Record/DF connector	D-sub 15pin (female)
all	9	LINE/AUX connector	D-sub 25pin (female)
all	10	Antenna	N-Type
TG660-25, -50	11	FWD. REV (Reflectometer)	Potentiometer (factory calibration only)
TG660-25, -50	12	Fan	

2.6.1 Connector MIC (Front)

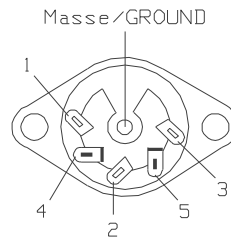

Figure 7: TG660 - Connector MIC (Front)

Pin	Name	Description
1	GND	AF Signal Ground, Mike Shield and Return for PTT
2	MIKE HI	Microphone AF Signal HI
3	HEADPHONE	Headphones AF Signal HI
4	MIKE LO	Microphone AF Signal LO
5	PTT	PTT Switch Input

2.6.2 Connector Remote Control (Rear)

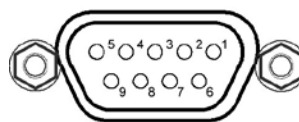

Figure 8: TG660 - Connector Remote Control (Rear)

Pin	Name	Description
1	RX-	RS422 Data line
2	TX-	RS422 Data line
3	RX+	RS422 Data line
4	TX+	RS422 Data line
5	Shield	GND
6	NC	not connected
7	NC	not connected
8	NC	not connected
9	NC	not connected

### 2.6.3 Connector Record/DF (Rear)

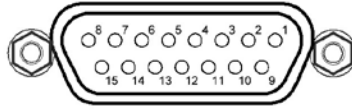

Figure 9: TG660 - Connector Record/DF (Rear)

Pin	Name	Description
1	DF_BL (HI)	DF Blank (HI)
2	DF_BL (LO)	DF Blank (LO)
3	GND	Ground
4	VR_Out (HI)	Voice Recorder out (HI)
5	VR_Out (LO)	Voice Recorder out (LO)
6	GND	Ground
7	NC	Not connected
8	VR_Act (HI)	Voice recorder control active (HI)
9	VR_Act (LO)	Voice recorder control active (LO)
10	NC	not connected
11	NC	not connected
12	NC	not connected
13	NC	not connected
14	NC	not connected
15	NC	not connected

## 2.6.4 Connector LINE / AUX (Rear)

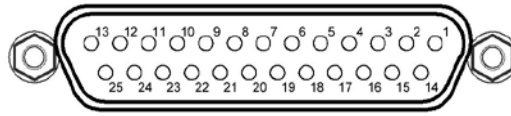

Figure 10: TG660 - Connector LINE / AUX (Rear)

Pin	Name	Description
1	DC Out	Auxiliary voltage output 12 V, max 1 A
2	DC GND	Auxiliary voltage ground
3	Line Out (HI)	AF output 0 dBm 600 Ω
4	Line Out (LO)	AF output 0 dBm 600 Ω
5	PTT Line (HI)	PTT activation
6	SQL Line (HI)	Squelch output HI
7	Line IN (HI)	AF input 0 dBm 600 Ω
8	Line IN (LO)	AF input 0 dBm 600 Ω
9	Line IN (C)	AF input transformers centre connection
10	RX_AGC	Receiver audio gain control output
11	Mike EXT (Std)	External microphone input Electret
12	Mike EXT (Dyn)	External microphone input Dynamic
13	Chassis	Chassis ground
14	PTT Line (LO)	PTT activation LO
15	SQL Line (LO)	Squelch output LO
16	Line Out (C)	Line Out transformer centre connection
17	PTT ext. (HI)	External PTT HI
18	PTT ext. (LO)	External PTT LO
19	NC	not connected
20	AF GND	AF ground
21	SPK (HI)	Loudspeaker signal
22	SPK GND	Loudspeaker ground
23	Error (HI)	Error detection, potential-free
24	Error (LO)	Error detection, potential-free
25	Chassis	Chassis ground

### 2.6.5 Connector EXT. DC (Rear)

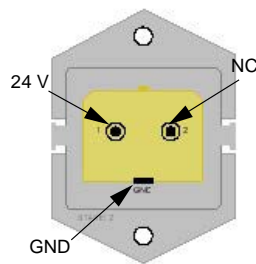

Figure 11: TG660 - Connector EXT. DC (Rear)

- Connect the 24 VDC supply cable to this socket.
- Use a cable of  $\geq 1.5 \text{ mm}^2$ .

### 2.6.6 Connector AC/Line Power Supply (Rear)



Figure 12: TG660 - Connector AC/Line Power Supply (Rear)

- The AC/Line panel provides a socket to connect 220V/115V.
- Additionally, an ON/OFF switch to disconnect AC power from all TG660 circuits.

#### NOTICE

- The TG660 power supply logic operates with AC power by default. After AC power failed, the logic automatically switches over to DC power. TG660-25/50 will draw current partially also from DC source in case both power sources are connected.
- An optional internal 12 VDC rechargeable battery, installed inside the TG660-05/10, provides the power to continue operation of the TG660 in case AC and DC supply voltage fails at the same time.
- During battery operation the TX power of a 10 W transceiver will be reduced to 6 W (emergency operation).
- In battery mode the TG660 will operate for around 4 h (duty cycle 20%), if the battery is fully loaded. However, the operational time is strongly dependent on its utilization.
- The capacity of the battery is reduced over its lifetime, which depends on various factors (e.g. number of cycles, storage/operating temperature, etc.). Check the operational time of the battery regularly to ensure that the capacity of the battery is sufficient for its application. Otherwise the battery needs to be replaced.



## 2.6.7 Reflectometer / RF Power Monitor

RF power monitor is continuously monitoring the forward and reflected power. In case of antenna mismatch the VSWR LED lights up (LED at the front panel). The RF power monitor limits are calibrated at the factory.

If VSWR LED lights up – please check antenna cabling.

## 2.7 Wiring

### SAFETY INSTRUCTIONS

Installation of the device(s) varies according to mounting location and equipment design. It is therefore only possible to provide general guidelines in this section.

### 2.7.1 Microphone Connection

#### 2.7.1.1 Mike Connector (MIC)

The microphone connection "MIC" is foreseen connecting dynamic microphones by default, carbon microphone operation available from configuration only.

The signals "MIKE (HI)" and "MIKE (LO)" are the balanced AF inputs of the TG660

Input impedance            200  $\Omega$ ,

nominal input voltage    10 mV.

MIKE (HI)            Pin 2                    Microphone AF signal

MIKE (LO)           Pin 4                    Microphone AF signal

#### 2.7.1.2 External Microphone (LINE AUX )

The TG660 allows the connection of an external microphone (connector LINE / AUX). If respectively configured the microphone amplifier can operate with both, standard carbon- or dynamic mike.

### Microphone Selection

The microphone type can be selected via the web browser connection. Adjustment of input levels and priority for connected microphones also provided.

#### Standard (carbon) Microphone

For operation with standard microphone (carbon) the station has a balanced input with input resistance 150  $\Omega$  and nominal sensitivity 250 mV. 12 VDC power for standard microphones provided via a feed resistor 470  $\Omega$ .

#### Dynamic Microphone

For operation with dynamic microphone, the station has a balanced input with an impedance of 200  $\Omega$  input resistance and a nominal sensitivity of 2 mV.

### 2.7.2 Record/DF Connection

#### 2.7.2.1 AF Output to Voice Recorder

TX side tone and RX AF signals from the ground station are present at this output.

The output is galvanically decoupled from housing and internal signal ground.

Nominal load resistance            600  $\Omega$

Nominal output level                547 mV @600  $\Omega$

VR\_OUT (HI)                    Pin 4                    Audio to Voice Recorder

VR\_OUT (LO)                    Pin 5                    Audio to Voice Recorder

## Wiring

**2.7.2.2 Voice Recorder Control**

This signal provides control of the voice recorder.

Maximum switching current 20 mA. Voltage drop at 20 mA not more than 1 V.

Maximum switching voltage +65 V (optically-isolated contact)

The switch closes, either if TX is active or if RX squelch is open. This means, both transmit and receive signals are recorded if a voice recorder is connected.

VR_ACT (HI)	Pin 8	Voice Recorder Activation Control
VR_OUT (LO)	Pin 5	Voice Recorder Activation Control

**2.7.2.3 Direction Finder Blank-Out**

The switching output provides automatic control to blank-out during transmit the Direction Finder (blanks out Direction Finder during transmission).

The switch (optically-isolated contact) is closed if TX is active.

Maximum switching current 20 mA. Voltage drop at 20 mA not more than 1 V.

Maximum switching voltage +65 V

DF_BL (HI)	Pin 1	DF Blanking Signal
DF_BL (LO)	Pin 2	DF Blanking Signal

**2.7.3 LINE / AUX Connection****2.7.3.1 PTT**

"PTT LINE" (HI/LO) - (optically decoupled PTT input, active @12 V  $\pm$ 1 V). If 12 VDC applied to this input, TX activates and TX modulation input of the transceiver switches internally to "LINE IN" input.

PTT LINE (HI)	Pin 5	PTT connection, HI
PTT LINE (LO)	Pin 14	PTT connection, LO

**2.7.3.2 External Speaker**

TG660 allows connection of an external loudspeaker.

- The external loudspeaker must be connected to pin 21 "SPK HI" (+) and pin 22 "SPK GND" (-) of the "LINE AUX" connector.
- The cable length between speaker and connector shall be  $\leq$  3 m.
- The output is not galvanically decoupled.
- The "SPKR" (GND) lead connects internally to signal ground.
- The output "SPKR" (HI) has coupling capacitor, connected internally, in series.
- The max. output power is 4 W at 4  $\Omega$ .

**2.7.3.3 Headphone**

- Connect only headphones with an impedance of 600  $\Omega$  and a nominal input power of 100 mW to the headphone output on the front plate.
- This output is not galvanically decoupled.
- The "VOL" knob on the front panel allows control of audio loudness.

Phone	Pin 3	Headphones AF signal
GND	Pin 1	Signal ground

### 2.7.3.4 LINE IN / LINE OUT

"LINE IN" input is a balanced AF input.

An AF transformer decouples galvanically from housing and internal signal ground.

Nominal load resistance 600  $\Omega$

Nominal output level 0 dBm @600  $\Omega$

PTT control and CALL indication provided by using the center tap without additional control lines.

LINE IN (HI)	Pin 7	AF Signal from Communication Equipment
LINE IN (LO)	Pin 8	AF Signal from Communication Equipment
LINE IN (C)	Pin 9	Centre Tap of "LINE_IN" input

The LINE OUT output is a balanced AF output.

The "RX AF" signal from the station is present at this output.

By an AF transformer "LINE OUT" signal galvanically decouples from housing and internal signal ground.

Nominal load resistance 600  $\Omega$

Nominal output level 0 dBm @600  $\Omega$

LINE OUT (HI)	Pin 3	AF Signal from Communication Equipment
LINE OUT (LO)	Pin 4	AF Signal Communication Equipment
LINE OUT (C)	Pin 16	Centre Tap of "LINE OUT" output

### 2.7.3.5 SQL - LINE

The "SQL LINE" (HI/LO) is an optical-isolated switching control line.

The signal HI/LO indicates the presence of received RF signal.

RX squelch is open if the switch is closed. This signal provides indication of a call on remote communication equipment.

Maximum switching current 20 mA. Voltage drops at 20mA not more than 1 V

Maximum switching voltage 65 V

SQL LINE (HI)	Pin 6	CALL Indicator
SQL LINE (LO)	Pin 18	CALL Indicator

### 2.7.3.6 Input PTT MIKE\_EXT (HI/LO)

"PTT MIKE\_EXT" (HI/LO) - (optically decoupled PTT input, active @12 V  $\pm$ 1 V). If 12 VDC applied to this input, TX activates and TX modulation input of the transceiver switches internally to "MIKE\_EXT" input.

PTT ext. (HI)	Pin 17	PTT for external MIKE
PTT ext. (LO)	Pin 18	PTT for external MIKE

### 2.7.4 Auxiliary Voltage Output

The auxiliary voltage output is suitable for supply the optical isolated applications (connector LINE / AUX).

Output voltage 12 V @1 A max.

DC out	Pin 1	Auxiliary voltage output 12 V, max 1 A
DC GND	Pin 2	Auxiliary voltage ground

## 2.8 Configuration via PC

The access for configuration and operation of one or several TG660 via PC is provided by a web browser based solution, no local software installation is required.

### 2.8.1 Preparing the PC

To be able to access the web interface of the TG660, a PC has to be configured properly.

Ex factory, the network address of the TG660 is as follows:

- IP address: 192.168.16.191
- Subnet mask: 255.255.255.0

The configuration of the network settings works similarly under Windows XP, Vista, 7, 8 and 10. The following examples are for Win7. If you encounter any network problems, you might have to contact your local network administrator. If you do not know the IP address of your TG660 you can restart the radio to display the IP address in LCD.

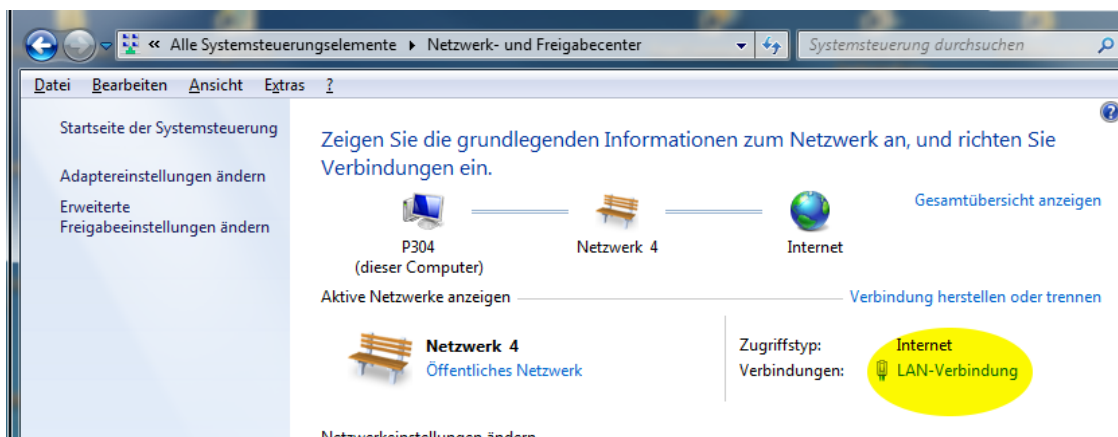

Figure 13: PC configuration: LAN network

- Open Control Panel (via the "Start" menu) and choose "View network status and tasks" (via "Network and Internet").
- On the following screen click on "LAN connection" (highlighted yellow).
- On the next screen "LAN connection status", click on "Properties" (you need administrator rights here), to get to the window "Properties of LAN connection".
- Choose "TCP/IP(v4)" and again click on "Properties".
- On screen "Properties of TCP/IP(v4)" choose "Advanced..." and click "Add..." in the IP address area.

- In the appearing input screen (see image) the first three numbers of the IP address must be chosen analogously to the TG660 address.
  - Each IP may only appear once in a given network, the fourth number must be different from the TG660 (0-254, not 191).
- The subnet mask is set to 255.255.255.0 as for the TG660.
- Confirm your input with "Add" and
- Close all previously opened screens with "OK" or "Close".



Figure 14: PC configuration: IP-address, sub net mask

In case the first 3 numbers of your PC's standard IP address are already 192.168.16.XXX, you can skip the previous steps, but you have to take care that no other device with the IP 191 (4th number) is connected to the network during configuration. In more sophisticated network architectures the range 192.168.16.XXX could also be already used in another network segment.

This kind of problems can be completely avoided if TG660 and PC are connected to a separate network hub or switch, which is solely used for that purpose.

## 2.8.2 Operating via PC

For details about operating via PC please see "Operating via PC", page 47.

## 2.9 Post Installation Check

Once the device(s) is installed completely do a test procedure to verify system functionality. Ensure compliance with authority required procedures. These sub-chapters provide guidance for such tests.

### 2.9.1 Mechanical Installation and Wiring Check

- Verify all cables are securely fixed and shields connected properly to signal ground.
- Verify all screws are tight and check if all connections are mechanically secured.

### 2.9.2 Power Supply

- Check the external DC connection and confirm correct polarity.

### 2.9.3 Receiver / Transmitter Operation

- Perform a voice communication test over a distance of at least 5km..
- Speak loud to the microphone and keep it always close to the lips, otherwise ambient noise can be intrusive and make understanding difficult.
- Use only microphones or headsets, which are suitable for ground-stations. Incoming radiation on the equipment antenna can affect the integrated amplifier of the microphone (feedback). This is noticeable in the station by whistling and/or heavy distortion. The described disturbances can occur in different ways on different transmit channels.
- Transmit buttons can stick or TX line is short circuited thus causing continuous carrier signal on the active channel. Therefore ensure that the display (sign “↑”) disappeared when the “TX” button is released.

### 2.9.4 Antenna Check

- Check the VSWR (voltage standing wave ratio) over the complete frequency band (e.g. by using a VHF Reflection-Coefficient Meter).  
The VSWR ratio should be less than 2:1 and is not acceptable when exceeding 3:1.

### 3 Operating Instructions

#### In this chapter you can read about:

In this chapter you can read about: .....	39
3.1 Device Description .....	39
3.1.1 Device Assignment .....	39
3.1.2 Packing, Transport, Storage .....	39
3.1.3 Scope of Delivery .....	39
3.1.4 Type Plate .....	39
3.1.5 Controls and Indications .....	40
3.1.5.1 User Interface .....	40
3.1.5.2 Description of Displayed Information .....	41
3.2 Start up .....	41
3.2.1 Power ON .....	42
3.2.2 Power on Built In Test (PBIT) .....	42
3.3 Operating .....	43
3.3.1 Keypad .....	43
3.3.2 SPKR Key .....	44
3.3.3 Mode Key .....	44
3.3.3.1 Channel Mode .....	44
3.3.3.2 Status of Supply Voltages .....	45
3.3.4 SQL Key .....	45
3.3.5 PTT Key .....	45
3.3.6 Storage Procedure .....	46
3.4 Operating via PC .....	47
3.4.1 Interface RoIP .....	47
3.4.2 Menus .....	48
3.5 Selectable Frequencies .....	49
3.6 Contact Data .....	50

#### 3.1 Device Description

TG660 is a fixed station for voice communications in the VHF frequency range of 118.000...136.990 MHz with 25 kHz / 8.33 kHz channel spacing.

##### 3.1.1 Device Assignment

This manual is valid for the following devices:

- See page 24

##### 3.1.2 Packing, Transport, Storage

- See page 24

##### 3.1.3 Scope of Delivery

- See page 24

##### 3.1.4 Type Plate

- See page 25

### 3.1.5 Controls and Indications

#### 3.1.5.1 User Interface



Figure 15: TG660 – Controls and Indications

	Description	Function
A	Loudspeaker	Internal loudspeaker
B	VOL (knob)	Adjustment of loudspeaker volume.
C	MIC (connector)	Connection of a dynamic hand mike or a head set.
D	Display	LCD output device to display information, see "Description of Displayed Information", page 41.
E	SPKR (key+LED)	Switching "ON/OFF" the internal and external loudspeaker. LED: Lights up when the internal speaker is enabled.
	MODE (key+LED)	Selection of modes: <ul style="list-style-type: none"> <li>• Normal operating mode (frequency selection via keypad)</li> <li>• Channel mode (selection of predefined channels)</li> <li>• Several long presses on the "MODE" key show the status of different supply voltages (e.g. radio, DC-internal and optional battery).</li> </ul> LED: Lights up when the system self-test detects an error.
	SQL (key+LED)	Switching "ON/OFF" the squelch function. Access to the SQL threshold settings. LED: Lights up during receive of a signal. LED is blinking when SQL is disabled.
	PTT (key+LED)	Switching from voice reception mode to transmit mode. LED: Lights up during the transmit mode. LED is blinking until keying interrupts.
F	Numerical keypad	Use key "E" to confirm keypad entries. Use key "S" for storage operations. Use keys "0...9" for numerical inputs.
G	AC / DC LEDs	Indicate which supply voltage is available.
H	STANDBY (switch)	Switching "ON/OFF" the TG660.
I	VSWR LED	Indicates antenna mismatching (TG660-25, TG660-50 only)

The device detects a:

**"Long press"**: when pressing a key for at least 1 second.

**"Short press"**: any pressing below 1 second.



### 3.1.5.2 Description of Displayed Information

The display can show various information and symbols in two lines.

Indication / Information	Description
in lower line	Shows: <ul style="list-style-type: none"> <li>Active transmit/receive frequency</li> </ul>
in upper line	Shows: <ul style="list-style-type: none"> <li>Internal DC supply voltage and optional battery voltage (if a battery is installed, otherwise shows 00.0 V)</li> </ul>
Symbol: ↑	Shows: <ul style="list-style-type: none"> <li>Transmit mode (PTT active)</li> </ul>
Symbol: ↓	Shows: <ul style="list-style-type: none"> <li>Receive signal detected</li> </ul>
Symbol: battery	Shows: <ul style="list-style-type: none"> <li>Battery voltage status</li> </ul> The 'X' in the battery symbol indicates no battery option installed. Not shown on configuration pages.

#### Examples:

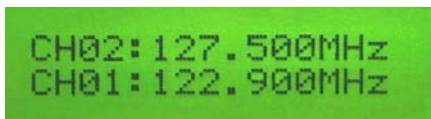

Shown is:

- Preset frequency (first row).
- Active transmit/receive frequency (second row).



Shown is:

- Active transmit/receive frequency
- Status of the battery

The 'X' in the battery symbol indicates no battery option installed.

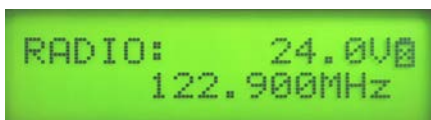

Shown is:

- Radio Voltage
- Active transmit/receive frequency

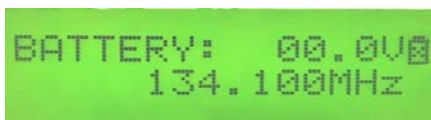

Shown is:

- Voltage of the internal battery (optional battery).
- Active transmit/receive frequency



Shown is:

- Radio power supply voltage
- Voltage of the internal battery
- Active transmit/receive frequency

## 3.2 Start up

The TG660 power supply logic is operating with AC-power by default.

After AC power failed, the logic automatically switches over to DC power. The moment AC power becomes available the logic returns back to AC power source.

An optional internal 12 VDC battery inside the TG660, if installed, could provide power for continued operation over a certain time if AC and DC supply voltage would fail at the same time.

After a changeover from AC to DC power or vice-versa, the station is operable with the same functions and settings as before.

## Start up

**3.2.1 Power ON**

Use STANDBY switch to power ON the TG660.

- The Logo "Becker Avionics" is displayed for 2 s.
- LED "AC" and "DC" lights up depending on power supply source.

**3.2.2 Power on Built In Test (PBIT)**

- PBIT starts a display dimming test from minimum to maximum brightness.
- After the dimming test "Becker Avionics and TG660" appears for 2 s on the display.



Figure 16: TG660 – Display after power on

- PBIT starts the next test; various steps run through from first to final step in a 2 s interval.

**1.Step: The top line can show different information.**

- The bottom line shows the last used frequency.

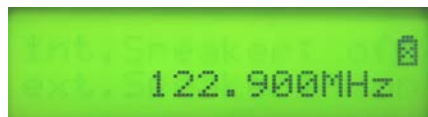

Figure 17: TG660 – PBIT, 1.Step

**2.Step: Shows a sample of the top line with the last used mode after a power cycle.**

- Depending on customers last used mode different information can appear.
- The top line shows the status of the optional internal battery, if installed.
- If not installed, the battery symbol is crossed out.
  - During battery detection voltage counts down until 0 volts.



Figure 18: TG660 – PBIT, 2.Step

**3.Step: Shows figures of the IP address in the top line.**

Figure 19: TG660 – PBIT, 3.Step

4.Step: Shows figures of the subnet mask in the top line.



Figure 20: TG660 – PBIT, 4.Step

5.Step: Shows the port number in the top line



Figure 21: TG660 – PBIT, 5.Step

6.Step: Shows the display in last used mode which become active after the PBIT is completed successful.

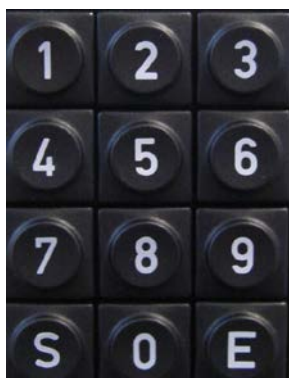

Figure 22: TG660 – PBIT, 6.Step

**Note:** After successful PBIT the device comes back to the setting before powered off.

### 3.3 Operating

#### 3.3.1 Keypad



**Use keypad for changing the frequency.**

- Type in all 6 digits of the desired frequency
- Confirm the input with key "E"

#### **NOTICE**

Only 25 / 8.33 kHz frequencies are accepted (details see "Selectable Frequencies" page 49.

If the frequency is not included in the 25 / 8.33 kHz channel spacing the upper line blinks.

### 3.3.2 SPKR Key

Switching "ON/OFF" the internal and external loudspeakers. SPKR key LED lights up when the internal speaker is enabled.

```
int.Speaker: on
ext.Speaker: off
```

#### Press SPKR key 1st time (short press).

- Internal speaker is switched on
- SPKR key LED is on

```
int.Speaker: off
ext.Speaker: off
```

#### Press SPKR key 2nd time (short press).

- Internal speaker is switched off
- SPKR key LED is off

```
int.Speaker: on
ext.Speaker: off
```

#### Press SPKR key (long press).

- External speaker is switched on

```
int.Speaker: off
ext.Speaker: off
```

#### Press SPKR key again (long press).

- External speaker is switched off

#### Note:

- It is also possible to switch on both, internal and external speaker.
- The status of the external and internal speaker is shown for approx. 1 s.
- The internal loudspeaker switch off automatically during TX. This avoids acoustic coupling between loudspeaker and microphone, which can cause acoustical feedback.

### 3.3.3 Mode Key

Selection of modes:

- Normal operating mode (frequency selection via keypad).
- Channel mode (selection of predefined channels).
- Status of different supply voltages (e.g. radio, DC-internal and optional battery).

#### 3.3.3.1 Channel Mode

```
CH02: 127.500MHz
```

#### Press MODE key (short press).

- A channel input field is generated.  
Note: the editable field appears after input of the first digit.

```
CH02: 127.500MHz
CH01: 122.900MHz
```

- Type in the desired channel number e.g. 02.
- Confirm the input with key "E".
- The frequency is stored in channel "CH02".

```
CH02: 127.500MHz
```

- After pressing key "E" the display shows the "new" stored channel frequency.

### 3.3.3.2 Status of Supply Voltages

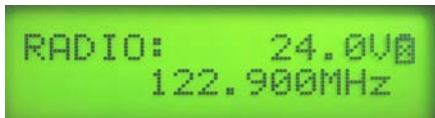

**Press MODE key 1st time (long press).**

The upper line of the display changes.

Shown is:

- Radio Voltage

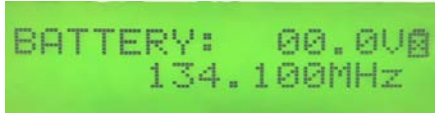

**Press MODE key 2nd time (long press).**

The upper line of the display changes.

Shown is:

- Voltage of the internal battery (optional battery).



**Press MODE key 3rd time (long press).**

The upper line of the display changes.

Shown is:

- Radio power supply voltage
- Voltage of the internal battery.

### 3.3.4 SQL Key

Switching "ON/OFF" the squelch function to suppress the sound of channel noise. Adjustment of the SQL threshold settings.

Symbol: ↓

**Press SQL key (short press).**

- Switches the SQL function "ON/OFF".

SQL function "ON":

- LED is on during receive of a signal.  
Symbol ↓ is displayed.

SQL function "OFF":

- LED is blinking.

**Press SQL key (long press)**

- Activates the SQL threshold setting function.
  - Press key "S" to decrease threshold.
  - Press key "E" to increase threshold.
- Next short press returns the TG660 into the previous mode.

### 3.3.5 PTT Key

Press PTT key (Press-to-Talk) to switch from voice reception mode to transmit mode.

Symbol: ↑

**Press PTT key (press and hold).**

- Activates the transmit mode.
- PTT key pressed: LED is on. Symbol ↑ is displayed.
- Ready to transmit messages.
- PTT key not pressed: LED is blinking.

**Note:**

- If transmit mode is "activated" for more than 2 minutes, the transmitter shuts down automatically.

### 3.3.6 Storage Procedure

Non-volatile memory for storing:

- 99 channels are available for the manually storage of frequencies.



Channel02 already used

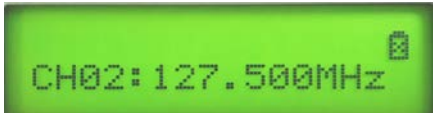

Channel02 free

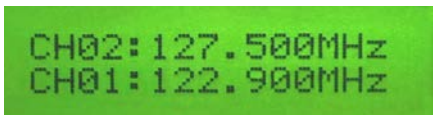

**Press key "S" to get in "Standard Mode".**

- The indicated frequency is provided to store.
- Type in the desired channel number e.g. 02.  
Note: the editable field appears after input of the first digit.

**Overwrites already used channels with the new frequency!**

- Press key "E" to confirm the input.
- The frequency is stored in channel "CH02"

**"Chan. free" behind the channel number identifies vacant channel numbers.**

- Confirm the input with key "E"
- The frequency is stored in channel "CH02"

### 3.4 Operating via PC

#### 3.4.1 Interface RoIP

Each TG660 in the application must have a separate IP address and can operate and be configured via PC.

**First steps:**

- Open the web browser on the PC.
- Type in the IP address and call up the web interface.
- Login with user name and password.  
 Default:       User name:    tg660  
                   Password:   radio
- Ready to operate with the called TG660.

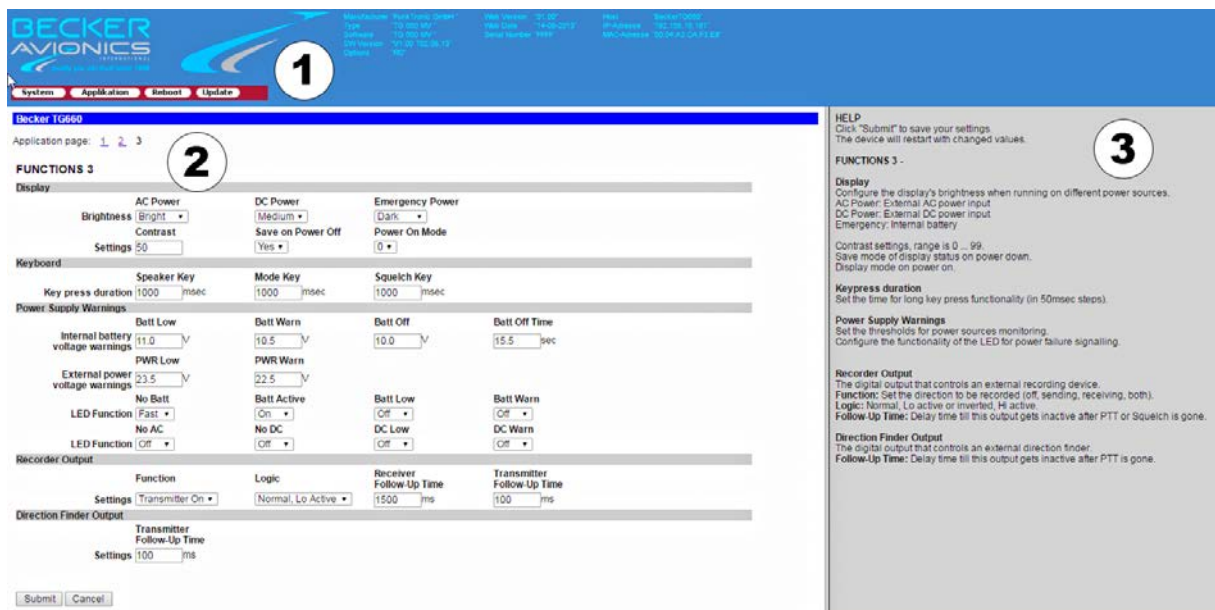

Figure 23: Interface: TG660 Radio over IP

	<b>The interface consists of 3 basic parts:</b>
<b>1</b>	<b>Header (blue) includes information about:</b> <ul style="list-style-type: none"> <li>• Web interface tool, version, network settings, ...</li> <li>• Device type, IP address, ...</li> <li>• Menu bar (System, Application, Reboot, Update)</li> </ul>
<b>2</b>	<b>Functions, settings (white) provides information/operations about:</b> <ul style="list-style-type: none"> <li>• System settings</li> <li>• Applications</li> <li>• Reboot process</li> <li>• Update process</li> </ul>
<b>3</b>	<b>Description (gray) includes information about:</b> <ul style="list-style-type: none"> <li>• Support and instructions according to the called menu page.</li> </ul>

### 3.4.2 Menus

#### The menu "System" consists of different pages + Info

- Page1: This page is used for radio settings (frequencies, channels, squelch).
- Page2: This page is used for global network settings.
- Page3: This page is used for settings for remote console connections.
- Page4: This page shows current status of radio.
- Page5: This page is used for security settings.
- Page Info: This page provides information about the selected connection and debug, syslog messages.

BECKER AVIONICS INTERNATIONAL

Manufacturer: "FunkeTronic GmbH"  
 Type: "TG 660 MV"  
 Software: "TG 660 MV"  
 FW Version: "1.7.10 18.08.18"  
 Options: "MC"

Web Version: "01.10"  
 Web Date: "28.05.2018"  
 Serial Number: "0140"

Host: "BeckerTG660"  
 IP-Adresse: "192.168.18.191"  
 MAC-Adresse: "00:04:A3:CA:F3:EP"

System Application Reboot Update

Becker TG660

System page: 1 2 3 4 5 Info

#### RADIO SETTINGS

Channel / Frequency

Frequency	Current	New (118-137MHz)
	CH04:122.900MHz	<input type="text"/> Set

Channel Configuration	Channel	Frequency
	01	118.000 <input type="text"/> Select
	02	127.500 <input type="text"/> Select
	03	136.980 <input type="text"/> Select
	04	122.900 <input type="text"/> Select
	05	121.275 <input type="text"/> Select
	06	134.100 <input type="text"/> Select
	07	118.050 <input type="text"/> Select
	08	<input type="text"/> Select
	09	<input type="text"/> Select

← First ← Prev ↓ Save Next → Last →

#### Squelch

Squelch Level (G-26dB)  Set

#### Power Supply

Voltage	Radio	Battery	Battery Status
	24.0V	12.2V	Charging, Voltage 14.4V

Cancel

Figure 24: System page1 - Radio Settings

#### The menu "Application" consists of three pages

- Page1: This page is used for PTT sources, priority and monitoring
- Page2: This page is used for AF level settings.
- Page3: This page is used for configurations for display brightness, key press duration, threshold for warnings, ....

#### The menu "Reboot" consists of one page

- "Reboot": reboots the device. All settings will be reinitialized.
- "Factory defaults": Device will be reset to factory default settings and rebooted.

#### The menu "Update" consists of one page

- "Upload": use this function for updates of the web configuration interface. Updates are only necessary if they are requested from Becker Avionics.

**Note:** New software releases would be provided to authorized dealers only.



### 3.5 Selectable Frequencies

The table shows the relation between the real operating frequency and the selected frequency according to international standards. (refer to: EUROCAE ED-23C, chapter 1.3.2, or corresponding ICAO publications).

Channel Name	Channel Frequency	Channel Spacing
118.000	118.0000 MHz	25 kHz
118.005	118.0000 MHz	8.33 kHz
118.010	118.0083 MHz	8.33 kHz
118.015	118.0166 MHz	8.33 kHz
118.025	118.0250 MHz	25 kHz
118.030	118.0250 MHz	8.33 kHz
118.035	118.0333 MHz	8.33 kHz
118.040	118.0416 MHz	8.33 kHz
118.050	118.0500 MHz	25 kHz
118.055	118.0500 MHz	8.33 kHz
118.060	118.0583 MHz	8.33 kHz
118.065	118.0666 MHz	8.33 kHz
118.075	118.0750 MHz	25 kHz
118.080	118.0750 MHz	8.33 kHz
118.085	118.0833 MHz	8.33 kHz
118.090	118.0916 MHz	8.33 kHz
118.100	118.1000 MHz	25 kHz
...	...	...
136.975	136.9750 MHz	25 kHz
136.990	136.9916 MHz	8.33 kHz

### **3.6 Contact Data**

In case of additional questions contact your local Becker Avionics dealer or forward your request direct to Becker Avionics "Customer Service".

In the event of damage or a defect, the entire device must be returned for repair. The repair must be performed by trained Becker Avionics personnel.

**For relevant department and addresses, please see contact info page 2.**

### **User Conversions and Changes are Not Permitted**

Any change performed by the user excludes any liability on our part (excluding excluding the work described in this manual).

## 4 Certificates

### In this chapter you can read about:

4.1	Certificate-Info .....	51
4.2	BAF Approval - TG660 .....	52
4.3	EC Declaration of Conformity – TG660-05 .....	54
4.4	EC Declaration of Conformity – TG660-10 .....	56
4.5	CE Declaration of Conformity – TG660-25, TG660-50 .....	58
4.6	Approval - Telecommunication Office Italy – TG660-05, TG660-10.....	59

### 4.1 Certificate-Info

For detailed information about approvals and certification please see "Certifications", page 19.

## 4.2 BAF Approval - TG660



Bundesaufsichtsamt  
für Flugsicherung

# Urkunde

Ein(e)	<b>VHF- Bodenfunkstelle des Flugfunkdienstes</b>
Typ	<b>TG660 in den im Anhang zur Zulassungsurkunde aufgeführten Modellvarianten und zugehörigen Hard- / Softwarekonfigurationsständen</b>
Frequenzbereich	<b>118 – 136,975 MHz</b>
Kanalraster	<b>8,33 kHz / 25 kHz</b>
der Firma	<b>Becker Avionics GmbH Baden-Airpark B108 77836 Rheinmünster</b>
bestehend aus	<b>Sende-/Empfangseinheit (<math>\geq 6</math> W oder <math>\geq 10</math> W) in 19“ Baugruppenträger</b>
für die Betriebsart	<b>6K80A3EJN (25 kHz) / 5K00A3EJN (8,33 kHz)</b>

ist auf Einhaltung der Anforderungen an Anlagen und Geräte für Zwecke der Flugsicherung gemäß § 4 Flugsicherungs-Anlagen- und Geräte-Musterzulassungs-Verordnung (FSMusterzulV) geprüft worden.

Die Anlage oder das Gerät entspricht damit den Festlegungen des Bundesministeriums für Verkehr und digitale Infrastruktur hinsichtlich Art, Umfang und Beschaffenheit von flugsicherungstechnischen Einrichtungen gemäß § 32 Abs. 4 des Luftverkehrsgesetzes sowie der Richtlinien und Empfehlungen der Internationalen Zivilluftfahrt-Organisation (ICAO).

Es wird daher als Muster mit den umseitig aufgeführten Auflagen in der Bundesrepublik Deutschland zugelassen.

Der Gerätetyp hat die Zulassungsnummer **D-0046/2017** erhalten.

Bundesaufsichtsamt für Flugsicherung  
Langen, den 28.08.2017

Im Auftrag

Bodo Heinzl



Bundesaufsichtsamt  
für Flugsicherung

## Anhang zur Zulassungsurkunde D-0046/2017

Konfigurationsstand

Ausgabestand 28.08.2017

**VHF-Bodenstation TG660**

Modellvariante	Artikelnummer	Softwareversion
TG660-05	0635.367-926	SCI1051S305 (Chassis Module) SCI 1080 S 306 (Control-Board µC-Software) SCI 1079 S 306 (IF-Board MC-Software)
TG660-10	0635.375-926	SCI1051S305 (Chassis Module) SCI 1080 S 306 (Control-Board µC-Software) SCI 1079 S 306 (IF-Board MC-Software)

Bundesaufsichtsamt für Flugsicherung  
Langen, den 28.08.2017

Im Auftrag

Bodo Heinzl

4.3 EC Declaration of Conformity – TG660-05

**EC Declaration of Conformity /**  
**EC Declaration of Suitability for Use**



<b>EC Declaration of Conformity / EC Declaration of Suitability for Use for Constituents</b>	
<b>Name and address of manufacturer :</b>	<b>Constituent / application area</b>
Becker Avionics GmbH Baden Airpark, Building B108 77836 Rheinmünster Germany	TG660-05 VHF-Ground Station, communication system for ground-to-air communication
<b>System classification:</b>	Communication system for ground-to-air communication
<b>Part 1: General information about the constituent in accordance with Regulation (EC) 552/2004, Annex III</b>	
<b>1.1 Regulation Reference Number</b>	
Basic requirements in accordance with <ul style="list-style-type: none"> <li>Regulation (EC) No. 552/2004 Part A and Part B, subchapter 1 and 4.</li> <li>Implementing Regulation (EC) No. 1079/2012</li> <li>Directive 2014/53/EU</li> </ul>	
<b>1.2 Manufacturer information</b>	
Becker Avionics GmbH, Baden Airpark, Building B108, 77836 Rheinmünster, Germany.	
<b>1.3 Description of the constituents</b>	
The Ground Station Becker TG660-05 is a stationary VHF-Transceiver for air traffic management.	
Frequency Range : 118.000 – 136.990 MHz	Channel spacing : 8.33 kHz/25 kHz
Transm. Power Output : ≥ 6 W	Frequency stability : ≤ 1 ppm
Supply Voltage. : 24 VDC (21...29.8) VDC	Weight : 4.5 kg
Temperature Range: -20 °C - +55 °C	Dimensions W x D x H : 86.5 x 428 x 280 mm <sup>3</sup> (case only) 88.1 x 482.6 x 280 mm <sup>3</sup> (complete unit 19")
More detailed technical data about the transceiver itself and his physical interfaces as well as the limits of operation are given by the Installation and Operation Manual.	
<b>1.4 Description of the procedure followed in order to declare the system's conformity or suitability for use</b>	
Conformity is stated and has been verified in accordance with decision 768/2008/EC Annex II, Module A1.	
<b>1.5 Relevant regulations</b>	
<ul style="list-style-type: none"> <li><b>ETSI EN300 676-1 V1.5.2</b> : Ground-based VHF hand-held, mobile and fixed radio transmitters, receivers and transceivers for the VHF aeronautical mobile service using amplitude modulation Part 1: Technical characteristics and methods of measurement</li> <li><b>ETSI EN300 676-2 V1.5.1</b> : Ground-based VHF hand-held, mobile and fixed radio transmitters, receivers and transceivers for the VHF aeronautical mobile service using amplitude modulation</li> <li><b>EN 62311:2008</b> : Assessment of electronic and electrical equipment related to human exposure restrictions for electromagnetic fields (0 Hz – 300 GHz)</li> <li><b>DIN EN 60950-1 :2006 +A11:2009 + A12:2011 + A1:2010</b>: Information Technology Equipment – Safety</li> <li><b>EN 301 489-1 V1.9.2</b> : Electromagnetic compatibility and radio spectrum matters (ERM); Electro Magnetic Compatibility (EMC) standard for radio equipment and services; Part 1 : Common technical requirements</li> </ul>	

**EC Declaration of Conformity /**  
**EC Declaration of Suitability for Use**



- **EN 301 489-22 V1.3.1** : Electromagnetic compatibility and Radio spectrum Matters (ERM); Electro Magnetic Compatibility (EMC) standard for radio equipment and services; Part 22 : Specific conditions for ground based VHF aeronautical mobile and fixed radio equipment
- **SSB FL 021** : Schnittstellenbeschreibung für Bodenfunkstellen des mobilen Flugfunkdienstes
- **ICAO Annex 10** to the Convention on International Civil Aviation, Volume III and Volume IV

**1.6 Notified body**

CTC advanced GmbH, Untertürkheimer Strasse 6 – 10, 66117 Saarbrücken/Germany

**1.7 References to the community specifications**

The device complies with the regulations and directives :

- **Regulation (EC) No. 552/2004 Part A and Part B, subchapter 1 and 4.**  
Regulation on the interoperability of the European Air Traffic Management network.
- **Implementing Regulation (EC) No. 1079/2012**  
Laying down requirements for voice channels spacing for the single European sky.
- **Directive 2014/53/EU**  
Radio Equipment Directive (RED)
- **Regulation (EC) No. 550/2004**  
Regulation on the provision of air navigation services in the single European sky.

**1.8 Information about the authorized signatures**

- |  |  |
|--|--|
| 1.) <i>Dipl.- Ing. Jürgen Schiller, QA-Manager</i><br><u>Address :</u><br>Becker Avionics GmbH<br>Baden Airpark, Building B108<br>77836 Rheinmünster, Germany<br>Tel.: 07229/305-202<br>e-mail : juergen.schiller@becker-avionics.de | 2.) <i>Dr. Ingo Pletschen, Product Manager</i><br><u>Address :</u><br>Becker Avionics GmbH<br>Baden Airpark, Building B108<br>77836 Rheinmünster, Germany<br>Tel.: 07229/305-104<br>e-mail : ingo.pletschen@becker-avionics.de |
|--|--|

**Part 2: Declaration:**

Becker Avionics GmbH, 77836 Rheinmünster declares herewith that above mentioned constituents

- have been assessed in terms of compliance with the above mentioned standards and the compliance has been ascertained;
- have been considered in terms of its suitability within the environment of air traffic management and have been classified as suitable.

<b>Place of issue, Date</b>  Rheinmünster September 18 <sup>th</sup> , 2017	<b>1<sup>st</sup> Signature</b> On behalf :  Dipl.- Ing. Jürgen Schiller	<b>2<sup>nd</sup> Signature :</b> On behalf (in representation Peter Fritz)  Dr. Ing. Ingo Pletschen
--	--	---

4.4 EC Declaration of Conformity – TG660-10

**EC Declaration of Conformity /**  
**EC Declaration of Suitability for Use**



<b>EC Declaration of Conformity / EC Declaration of Suitability for Use for Constituents</b>	
<b>Name and address of manufacturer :</b>	<b>Constituent / application area</b>
Becker Avionics GmbH Baden Airpark, Building B108 77836 Rheinmünster Germany	TG660-10 VHF-Ground Station, communication system for ground-to-air communication
<b>System classification:</b>	Communication system for ground-to-air communication
<b>Part 1: General information about the constituent in accordance with Regulation (EC) 552/2004, Annex III</b>	
<b>1.1 Regulation Reference Number</b>	
Basic requirements in accordance with <ul style="list-style-type: none"> <li>Regulation (EC) No. 552/2004 Part A and Part B, subchapter 1 and 4.</li> <li>Implementing Regulation (EC) No. 1079/2012</li> <li>Directive 2014/53/EU</li> </ul>	
<b>1.2 Manufacturer information</b>	
Becker Avionics GmbH, Baden Airpark, Building B108, 77836 Rheinmünster, Germany.	
<b>1.3 Description of the constituents</b>	
The Ground Station Becker TG660-10 is a stationary VHF-Transceiver for air traffic management.	
Frequency Range : 118.000 – 136.990 MHz	Channel spacing : 8.33 kHz/25 kHz
Transm. Power Output : ≥ 10 W	Frequency stability : ≤ 1 ppm
Supply Voltage. : 24 VDC (21...29.8) VDC	Weight : 4.5 kg
Temperature Range: -20 °C - +55 °C	Dimensions W x D x H : 86.5 x 428 x 280 mm <sup>3</sup> (case only) 88.1 x 482.6 x 280 mm <sup>3</sup> (complete unit 19')
More detailed technical data about the transceiver itself and his physical interfaces as well as the limits of operation are given by the Installation and Operation Manual.	
<b>1.4 Description of the procedure followed in order to declare the system's conformity or suitability for use</b>	
Conformity is stated and has been verified in accordance with decision 768/2008/EC Annex II, Module A1.	
<b>1.5 Relevant regulations</b>	
<ul style="list-style-type: none"> <li><b>ETSI EN300 676-1 V1.5.2</b> : Ground-based VHF hand-held, mobile and fixed radio transmitters, receivers and transceivers for the VHF aeronautical mobile service using amplitude modulation Part 1: Technical characteristics and methods of measurement</li> <li><b>ETSI EN300 676-2 V1.5.1</b> : Ground-based VHF hand-held, mobile and fixed radio transmitters, receivers and transceivers for the VHF aeronautical mobile service using amplitude modulation</li> <li><b>EN 62311:2008</b> : Assessment of electronic and electrical equipment related to human exposure restrictions for electromagnetic fields (0 Hz – 300 GHz)</li> <li><b>DIN EN 60950-1 :2006 +A11:2009 + A12:2011 + A1:2010</b>: Information Technology Equipment – Safety</li> <li><b>EN 301 489-1 V1.9.2</b> : Electromagnetic compatibility and radio spectrum matters (ERM); Electro Magnetic Compatibility (EMC) standard for radio equipment and services; Part 1 : Common technical requirements</li> </ul>	



**EC Declaration of Conformity /**  
**EC Declaration of Suitability for Use**



- **EN 301 489-22 V1.3.1** : Electromagnetic compatibility and Radio spectrum Matters (ERM); Electro Magnetic Compatibility (EMC) standard for radio equipment and services; Part 22 : Specific conditions for ground based VHF aeronautical mobile and fixed radio equipment
- **SSB FL 021** : Schnittstellenbeschreibung für Bodenfunkstellen des mobilen Flugfunkdienstes
- **ICAO Annex 10** to the Convention on International Civil Aviation, Volume III and Volume IV

**1.6 Notified body**

CTC advanced GmbH, Untertürkheimer Straße 6 – 10, 66117 Saarbrücken, Deutschland

**1.7 References to the community specifications**

The device complies with the regulations and directives :

- **Regulation (EC) No. 552/2004 Part A and Part B, subchapter 1 and 4.**  
Regulation on the interoperability of the European Air Traffic Management network.
- **Implementing Regulation (EC) No. 1079/2012**  
Laying down requirements for voice channels spacing for the single European sky.
- **Directive 2014/53/EU**  
Radio Equipment Directive (RED)
- **Regulation (EC) No. 550/2004**  
Regulation on the provision of air navigation services in the single European sky.

**1.8 Information about the authorized signatures**

- |   |   |
|---|---|
| <p>1.) <i>Dipl.- Ing. Jürgen Schiller, QA-Manager</i><br/> <u>Address :</u><br/>                 Becker Avionics GmbH<br/>                 Baden Airpark, Building B108<br/>                 77836 Rheinmünster, Germany<br/>                 Tel.: 07229/305-202<br/>                 e-mail : juergen.schiller@becker-avionics.de</p> | <p>2.) <i>Dr. Ingo Pletschen, Product Manager</i><br/> <u>Address :</u><br/>                 Becker Avionics GmbH<br/>                 Baden Airpark, Building B108<br/>                 77836 Rheinmünster, Germany<br/>                 Tel.: 07229/305-104<br/>                 e-mail : ingo.pletschen@becker-avionics.de</p> |
|---|---|

**Part 2: Declaration:**

- Becker Avionics GmbH, 77836 Rheinmünster declares herewith that above mentioned constituents
- have been assessed in terms of compliance with the above mentioned standards and the compliance has been ascertained;
  - have been considered in terms of its suitability within the environment of air traffic management and have been classified as suitable.

<p><b>Place of issue, Date</b></p> <p>Rheinmünster September 18<sup>th</sup>, 2017</p>	<p>1<sup>st</sup> Signature On behalf</p>  <p>Dipl.- Ing. Jürgen Schiller</p>	<p>2<sup>nd</sup> Signature : On behalf (in representation Peter Fritz)</p>  <p>Dr. Ing. Ingo Pletschen</p>
--	--	--

4.5 CE Declaration of Conformity – TG660-25, TG660-50

**Declaration of Conformity**

CE

This declaration is issued according to the below directives and standards. It confirms that the listed device complies with all essential requirements of the applicable directive. This declaration applies only to the sample and its technical documentation.

<b>Model Name:</b> TG660-50 & TG660-25 <sup>1</sup>	<b>Date of Issue:</b> 4/25/18
<b>Model Description:</b> Aeronautical base radio used for emergencies	<b>Manufacturer:</b> Becker Avionics GmbH
<b>Serial Number:</b> N/A	<b>Address:</b> Baden-Airpark B108 77836 Rheinmünster Deutschland / Germany

---

*The relevant standards are as follows*

EN 300 676-2 V2.1.1 (2015-12)  
EN 301 489-1 V1.9.2 (2016-04)  
EN 301 489-22 V1.3.1 (2003-11)  
IEC 62311 ed. 1.0 (2007-08)

Part 1: General information about the constituent in accordance with Regulation (EC) 552/2004, Annex III

1.1 Regulation Reference Number  
Basic requirements in accordance with

- Regulation EC No. 552/2004 Part A and Part B, subchapter 1 and 4
- Implementing Regulation (EC) No. 1079/2012
- Directive 2014/53/EU

I/We hereby attest, under our sole responsibility, that the subject equipment named above, has been designed to comply with the relevant sections of the EU standards.

<b>Signature:</b>	<b>Date:</b> 2018/05/22
<b>Name:</b> Jürgen Schiller	<b>Title:</b> QA-Manager

<sup>1</sup> Testing performed on model TG660-50 is applicable for model TG660-25 (which is the same device with reduced power)



Testing performed by:  
Compliance Testing, LLC  
1724 S. Nevada Way, Mesa, Arizona  
Tel: 480-926-3100, Fax: 480-92  
Website: [www.compliancetesting.com](http://www.compliancetesting.com)

**Accredited to:**  
ISO 17025 - #2152.01  
ISO 17065 - #2152.02

Page 1 of 1

Reference No.: p1640035

## 4.6 Approval - Telecommunication Office Italy – TG660-05, TG660-10

  <i>Ministero dello Sviluppo Economico</i> DIREZIONE GENERALE PER LA PIANIFICAZIONE E LA GESTIONE DELLO SPETTRO RADIOELETRICO ex Divisione II	Becker Avionics GmbH Baden-Airpark B, 108 77836 Rheinmunster GERMANIA e-mail: info@becker-avionics.de
 <small>000411924900</small>	per conoscenza D.G.P.G.S.R.-Ufficio IV                      Sede  D.G.A.T email: dgat.segreteria@mise.gov.it  Ispettorati Territoriali Repubblica                      Loro Sede
Ministero Sviluppo Economico Dipartimento per le Comunicazioni REGISTRO UFFICIALE Prot. n. 0041697 - 02/07/2014 - USCITA	
<b>Fasc. 349022</b>	
<p>OGGETTO: Notifica di immissione sul mercato ai sensi dell'art.6.4 del decreto legislativo 9 maggio 2001 n. 269, degli apparati marca Becker Avionics modelli GT6201-05, GT6201-05R, GT6201-10 e GT6201-10R destinati al servizio aeronautico di terra.</p> <p>Si prende atto della notifica pervenute a questa Direzione Generale, in data 23/6/14 e al riguardo si comunica che gli apparati in oggetto, se conformi a tutti i requisiti ed obblighi derivanti dall'applicazione del d.lgs 9.5.01 n.269 possono essere immessi sul mercato e possono essere utilizzati sul territorio nazionale <b>limitatamente</b> nella banda di frequenze prevista dal Piano nazionale di Ripartizione delle Frequenze di cui al decreto 13 novembre 2008 come ricetrasmittitori VHF destinati al servizio aeronautico di terra.</p> <p>Le caratteristiche tecniche dichiarate sono le seguenti:</p> <ul style="list-style-type: none"> <li>- Banda di frequenza: 118,0000-136,9916 MHz;</li> <li>- Spaziatura tra canali: 8,33kHz e 25kHz;</li> <li>- Modulazione: AM;</li> <li>- Potenza di uscita: 6W/10W;</li> <li>- Standard armonizzato di cui all'art.3.2 del d.lgs 9 maggio 2001, n.269: EN 300676-2 V1.5.1;</li> </ul> <p>Ai sensi dell'art. 6.3 del d.lgs citato in oggetto, il costruttore o la persona responsabile dell'immissione sul mercato degli apparati deve fornire all'utente le seguenti informazioni:</p> <ol style="list-style-type: none"> <li>1) come stabilito dal decreto legislativo 1° agosto 2003 n. 259 (Codice delle comunicazioni elettroniche), ai sensi degli artt. 104 paragrafo a), numero 1) e 126 comma 1, l'esercizio degli apparati in questione è subordinato rispettivamente al possesso dell' "autorizzazione generale" e del relativo "diritto individuale di uso";</li> <li>2) gli apparati sono destinati al servizio aeronautico di terra.</li> </ol>	
	Il Direttore Generale (dot.ssa Eva Spina)
1	
Viale America, 201 – 00144 Roma tel. +39 06 5444 2230 benedict.attili@mise.gov.it	

## 5 Index

Abbreviations .....	7	N-Surge-Suppressor .....	27
Accessories .....	20	PTT Key .....	45
Additional Conditions of Utilization .....	9	Radiation .....	26
Additional Required Equipment .....	24	Radio over IP .....	14, 15
Conditions of Utilization .....	9	RoIP .....	14, 15
Connector Pin Assignments .....	29	Selectable Frequencies .....	49
Controls and Indications .....	40	Short press .....	40
Device Assignment .....	39	Spare Parts .....	21
Dimensions .....	27	SPKR Key .....	44
Grounding .....	26	SQL Key .....	45
Interface RoIP .....	47	Start up .....	41
Keypad .....	43	Status of Supply Voltages .....	45
LAN connection .....	36	Storage Procedure .....	46
Lightning Protection .....	27	Type Plate .....	25
Long press .....	40	Units .....	8
Mode Key .....	44	User Interface .....	40
Mounting .....	26	Variants Overview .....	13, 14
Non Warranty Clause .....	9	Warranty Conditions .....	9

We reserve the right to make technical changes.  
 The data correspond to the current status at the time of printing.  
 © by Becker Avionics GmbH / all rights reserved

**\*\*\* End of the Document \*\*\***